



RESEARCH ARTICLE

TO EVALUATE AND COMPARE THE EFFECT OF DISINFECTANTS ON DIMENSIONAL STABILITY AND SURFACE QUALITY OF TWO COMMERCIALY AVAILABLE ZINC OXIDE-EUGENOL IMPRESSION PASTE MATERIALS -AN IN VITRO STUDY

*Dr. Abhijit P. Patil, Dr. Mahantesh Bembalgi, Dr. Raghunath Patil, Dr. Sounyala Rayannavar and Dr. Sayed M. Killedar

Department of Prosthodontics, K.L.E. V.K Institute of Dental sciences, K.L.E. University, Belgaum-590010, Karnataka, India

ARTICLE INFO

Article History:

Received 17th September, 2016
Received in revised form
20th October, 2016
Accepted 15th November, 2016
Published online 30th December, 2016

Key words:

Dimensional stability,
Surface quality,
Zinc oxide-eugenol impression paste material,
Disinfection.

ABSTRACT

Background and Objectives: Contaminated impressions can cross infect gypsum casts that are poured against them. Prosthodontic treatment procedure may begin with the making of the dental impression which forms the first link in the microbial contamination during dental care. The disinfectant must be effective antimicrobial agent, yet cause no adverse effect to the dimensional accuracy and surface features of the impression material and the resultant gypsum cast.

Method: 80 impressions of die constructed according to ADA specification No. 19 were made with special tray fabricated with two types of commercially available zinc oxide-eugenol impression paste materials and disinfected by 2% glutaraldehyde, 1:213 iodophor, 0.2% chlorhexidine gluconate and distilled water for five minutes followed by rinsing in a tap water and dried then kept in the water bath at 37°C, simulating the mouth temperature under the weight of 1 kilogram simulating operators finger pressure. Dimensions of the resultant casts made of type IV die stone poured after disinfection of impressions were measured using stereomicroscope. Surface quality of resultant casts was assessed by visual examination under stereomicroscope and grading of casts surfaces were done according to specific scoring system.

Conclusion: 1:213 Iodophor causes least dimensional and surface quality changes in impressions made from Denzomix and DPI zinc oxide-eugenol impression paste materials where as Chlorhexidine disinfectant causes more dimensional and surface quality changes. So it may be advisable to consider 1: 213 Iodophor as a selected disinfectant for disinfecting Denzomix and DPI zinc oxide-eugenol impression paste impression materials for 5 minutes.

Copyright©2016, Abhijit P. Patil et al. This is an open access article distributed under the Creative Commons Attribution License, which permits unrestricted use, distribution, and reproduction in any medium, provided the original work is properly cited.

Citation: Abhijit P. Patil, Mahantesh Bembalgi, Raghunath Patil, Sounyala Rayannavar and Sayed M. Killedar, 2016. "To evaluate and compare the effect of disinfectants on dimensional stability and surface quality of two commercially available zinc oxide-eugenol impression paste materials -an in vitro study", *International Journal of Current Research*, 8, (12), 43137-43143.

INTRODUCTION

There are number of means, through which dentist is exposed to risks of infection from a patient. Impressions may transmit infections to the dental personnel by transmission of infective viruses or bacteria, through blood and saliva on them from patient (Powell *et al.*, 1990; Neill *et al.*, 1992). Study by McNeill MRJ, Coulter W.A and Hussey D.L have shown that rinsing the impressions only reduced the number of micro organisms but did not fully eliminate them (Neill *et al.*, 1992). Other investigations have also reported the recovery of micro organisms from stone cast (Leung and Schonfeld, 1983; Watkinson, 1988). Recommendations for infection control in dental laboratory procedures have been made by American Dental Association (ADA) including disinfection of impressions before being transported to the laboratory (ADA, 1988).

*Corresponding author: Dr. Abhijit P. Patil,
Department of Prosthodontics, K.L.E. V.K Institute of Dental sciences, K.L.E. University, Belgaum-590010, Karnataka, India.

Considering zinc oxide-eugenol (ZOE) impression material, limited research data are available. Aim of the present study is to further evaluate the dimensional changes and also changes in surface detail reproduction, if any following disinfection in Environmental protection Agency (EPA) registered –ADA accepted disinfectants suggested for use in dental situations (Council on Dental Materials, 1991).

MATERIALS AND METHODS

Method of collection of data

Inclusion criteria

Void free impressions, Undistorted impressions, Completely recorded impressions.

Exclusion criteria

Impressions with voids, Incompletely recorded impressions, Distorted impressions.

Methodology

A) Fabrication of Master Die

A master die according to the ADA specified die (specification no. 19) (American Dental Association Guide to Dental Materials, 1977) was used in the study as shown in the figure (1). A stainless steel block was machined into a round base and a platform as shown in Figure (2). Two points namely x and x' were identified on the master die which were formed at the intersection of the 25 μ m (width) vertical line a and the two horizontal lines d₁ and d₂. Then distance between points x and x' was measured using stereomicroscope to evaluate the dimensional stability. As shown in Figure (1).

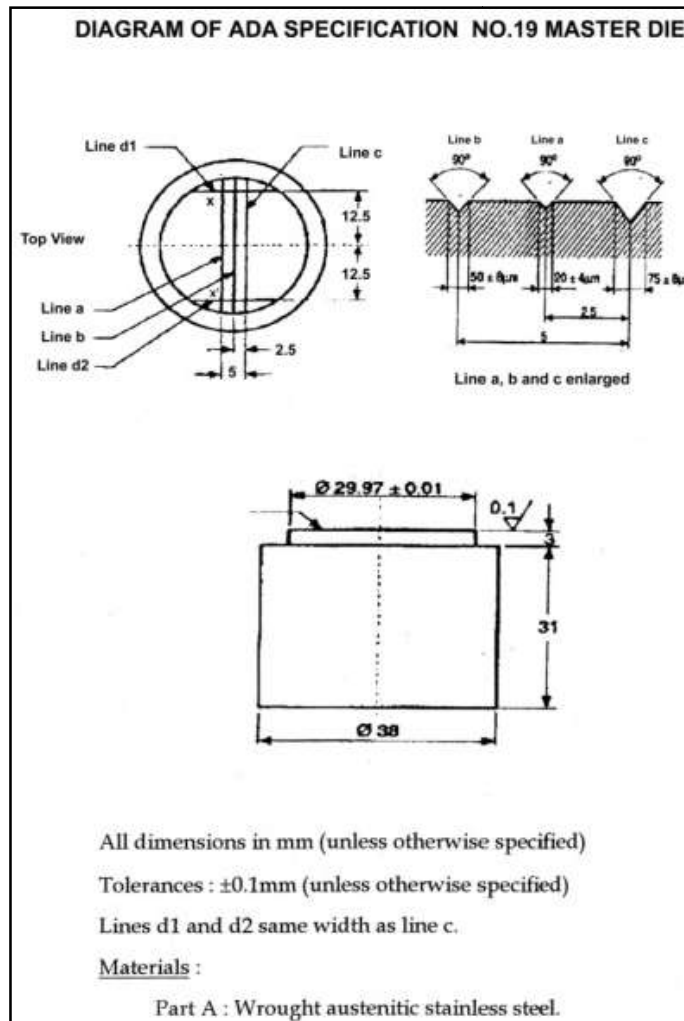

Figure 1. ADA specification No. 19 Master die

B) Fabrication of Special tray

A uniform 0.5 mm thickness of wax spacer was adapted on the master die (Smith *et al.*, 1999). Clear autopolymerising resin was mixed and then adapted over the master die to obtain a uniform thickness of 2 mm to prepare the impression tray. Total 80 impression trays were fabricated using the same methodology.

C) Impression Technique

The obtained impression trays were then placed in water for 24 hours so as to minimize distortion of the tray caused due to residual monomer content of the resin (Pagniano *et al.*, 1982).

Then zinc oxide-eugenol impression pastes (Denzomix and DPI) were mixed according to the manufacturer's instructions. Impression tray was then seated on the die and then was placed on the die orientation apparatus which applied a load of 1 kilogram so that the reference points and grooves were recorded properly in the impression as shown in Figure (3). The entire apparatus was then placed into a water bath at 37 + 2° C to simulate intraoral temperature until the material set completely (Ralph *et al.*, 1990). The impressions were then retrieved from the die.



Figure 2. ADA specification no.19 master die



Figure 3. Special tray with impression material in die orientation apparatus

D) Disinfection of the impressions

40 impressions of Denzomix (Type 1) and 40 impressions of DPI (Type 2) which were obtained were then divided into four groups comprising of 10 impressions for both Denzomix (Type1) and DPI (Type 2) pastes respectively. 10 impressions of each group were disinfected using 2% glutaraldehyde as shown in Figure (6), 1:213 idophor as shown in Figure (7), using 0.2% chlorhexidine gluconate as shown in Figure (8) and using Distilled water as shown in Figure (9) which was used as control. The four groups were then disinfected for five minutes followed by rinsing in tap water for ten seconds and then dried with a chip blower.

E) Fabrication of cast using type IV dental stone

For pouring the impressions, type IV dental stone was mixed according to manufacturer instructions. Casts poured were then allowed to set for one hour. After which the stone casts were retrieved from the impression trays. Similar procedure was followed to fabricate 80 stone casts as shown in Figure (10).

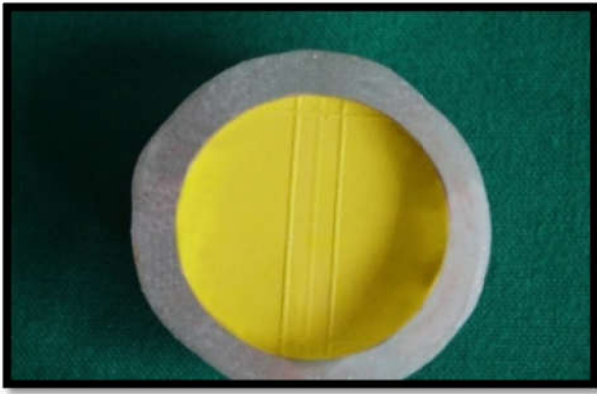

Figure 4. Type 1 zinc oxide-eugenol impression paste impression



Figure 5. Type 2 zinc oxide-eugenol impression paste impression



Figure 6. Disinfection in 2% Gluteraldehyde disinfectant

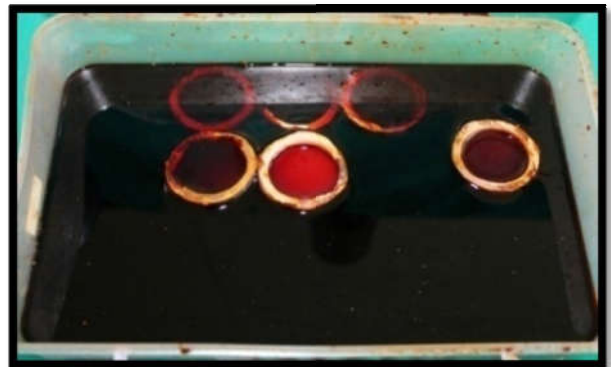

Figure 7. Disinfection in 1:213 Iodophor disinfectant



Figure 8. Disinfection in 0.2% Chlorhexidine gluconate disinfectant



Figure 9. Disinfection in Distilled water

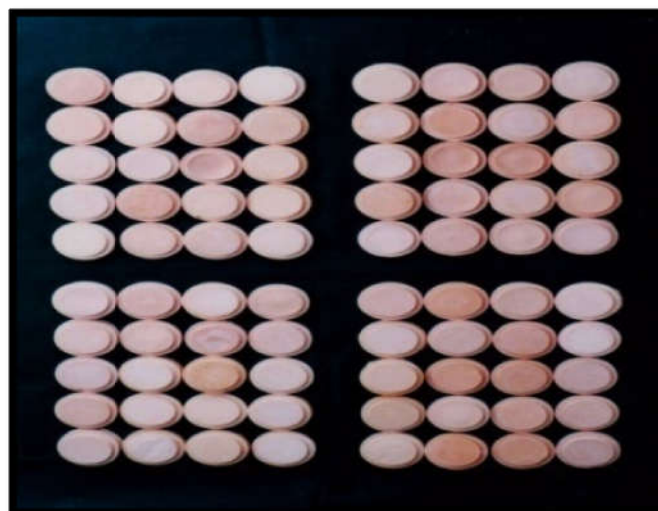

Figure 10. Type IV stone casts (Total 80)



Figure 11. Surface Quality scoring No.1



Figure 12. Surface Quality scoring No.2



Figure 13. Surface Quality scoring No. 3



Figure 14. Surface Quality scoring No.4

Table 1. Pair wise comparison of four disinfectant materials in type 1 impression material by Tukey's multiple post hoc procedures

Materials	Chlorhexidine	Gluteraldehyde	Iodophor	Distilled water
Mean	1.84	1.206	0.134	0.092
SD	0.109	0.075	0.089	0.037
Chlorhexidine	-			
Gluteraldehyde	P=0.0002*	-		
Iodophor	P=0.0002*	P=0.0002*	-	
Distilled water	P=0.0002*	P=0.0002*	P=0.6606	-

Table 2. Pair wise comparison of four disinfectant materials in type 2 impression material by Tukey's multiple post hoc procedures

Materials	Chlorhexidine	Gluteraldehyde	Iodophor	Distilled water
Mean	1.9055	1.3369	0.1959	0.0730
SD	0.0773	0.0902	0.0585	0.0557
Chlorhexidine	-			
Gluteraldehyde	P=0.0002*	-		
Iodophor	P=0.0002*	P=0.0002*	-	
Distilled water	P=0.0002*	P=0.0002*	P=0.0997	-

Table 3. Comparison of four disinfectant materials in type 1 impression material by one way ANOVA

Source of variation	Degrees of freedom	Sum of squares	Mean sum of squares	F-value	P-value
Between materials	3	21.90	7.2988	1084.2533	0.00001*
Within materials	36	0.24	0.0067		
Total	39	22.14			

Table 4. Comparison of four disinfectant materials in type 2 impression material by one way ANOVA

Source of variation	Degrees of freedom	Sum of squares	Mean sum of squares	F-value	P-value
Between materials	3	23.80	7.9320	1537.9936	0.00001*
Within materials	36	0.19	0.0052		
Total	39	23.98			

Table 5. Comparison of type 1 and type 2 materials in four disinfectant materials by t test

Materials	Impression materials	Mean	Std. Dev.	t-value	p-value
Chlorhexidine	Type 1	1.84	0.11		
	Type 2	1.91	0.08	1.5426	0.1403
Gluteraldehyde	Type 1	1.21	0.08		
	Type 2	1.34	0.09	3.5193	0.0024*
Iodophor	Type 1	0.13	0.09		
	Type 2	0.20	0.06	1.8221	0.0851
Distilled water	Type 1	0.09	0.04		
	Type 2	0.07	0.06	-0.9078	0.3760

Table 6. Comparison of three disinfectant materials with surface grades in type 1

Materials	Grade 1	%	Grade 2	%	Grade 3	%	Total
Chlorhexidine	0	0.0	6	60.0	4	40.0	10
Gluteraldehyde	3	30.0	7	70.0	0	0.0	10
Iodophor	7	70.0	3	30.0	0	0.0	10
Total	10	33.3	16	53.3	4	13.3	30

Chi-square=15.5002, p=0.0037*; Kruskal Wallis ANOVA, H=13.9450, p=0.0010*; Between Chlorhexidine Vs Gluteraldehyde, Z=-2.9360, p=0.0030*; Between Chlorhexidine Vs Iodophor, Z=-3.3420, p=0.0010; Between Gluteraldehyde Vs Iodophor, Z=-0.8900, p=0.3740

Table 7. Comparison of three disinfectant materials with surface grades in type 2

Materials	Grade 1	%	Grade 2	%	Grade 3	%	Total
Chlorhexidine	0	0.0	6	60.0	4	40.0	10
Gluteraldehyde	5	50.0	5	50.0	0	0.0	10
Iodophor	7	70.0	3	30.0	0	0.0	10
Total	12	40.0	14	46.7	4	13.3	30

Chi-square=17.0215, p=0.0019*; Kruskal Wallis ANOVA, H=13.8660, p=0.0010*; Between Chlorhexidine Vs Gluteraldehyde, Z=-2.5910, p=0.0100*; Between Chlorhexidine Vs Iodophor, Z=-3.3420, p=0.0010; Between Gluteraldehyde Vs Iodophor, Z=-1.7440, p=0.0810

Evaluation of Dimensional stability and Surface quality

The dimensional stability and surface quality was assessed using stereomicroscope with eye piece magnification of 10X and Zoom magnification of X 2.

a) Dimensional stability

The dimensional stability was calculated by using the following formula:

$$(L - L' / L) \times 100$$

Where

L - Represents the dimensions of the master die which were obtained by calculating the mean of three measurements, L' - Represents the mean dimension of the stone cast (control or after disinfection) which were obtained by calculating the mean of three measurements for the stone cast.

b) Surface quality

Surface quality of the resultant casts were assessed by visual examination under stereomicroscope at magnification of 10X and grading of casts surface were calculated according to specific scoring criteria as mentioned below. The results were then subjected to statistical analysis.

RESULTS

Statistical analysis

Data for the evaluation of dimensional stability will be analysed using

- One way ANOVA,
- Tukey’s multiple hoc procedures

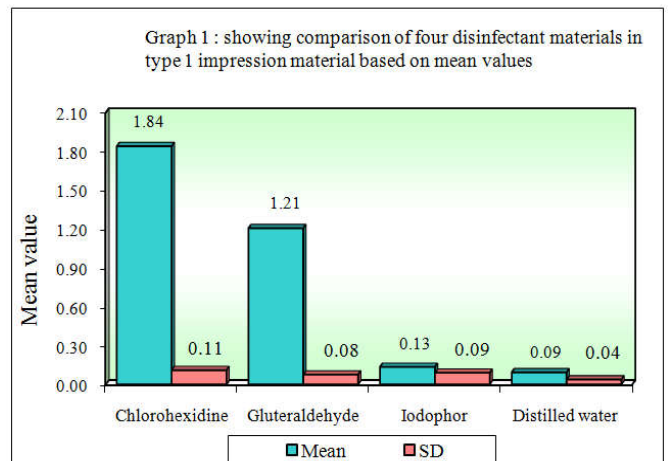

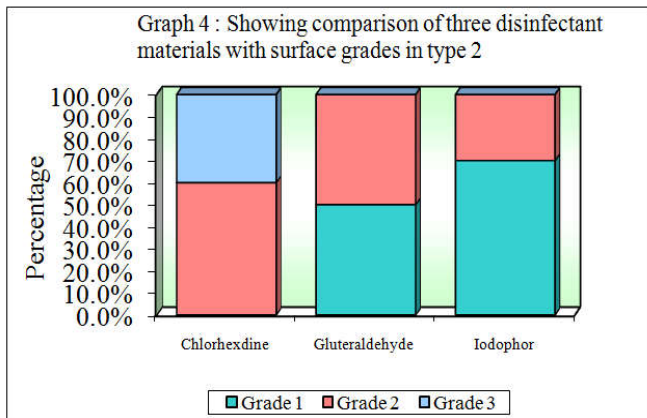
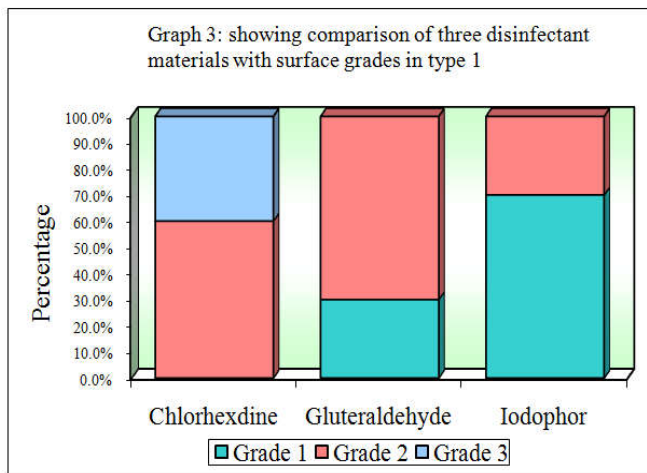
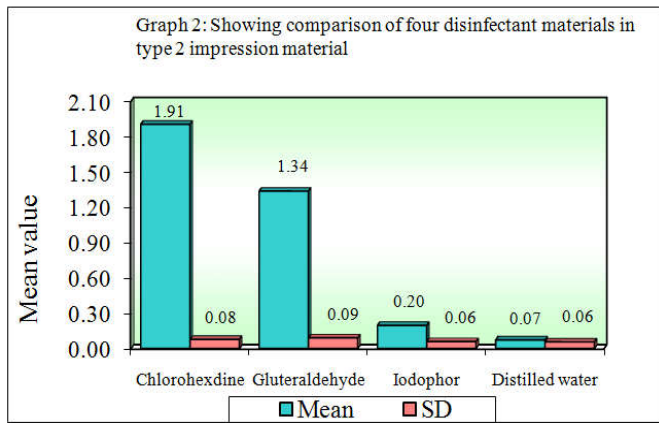

Data for the evaluation of surface quality will be analyzed using

- Chi – square test.
- Kruscal Wallis h- tests

DISCUSSION

The necessity for disinfecting the impression surfaces was realized as early as 1959 (Pleasure *et al.*, 1959). Solutions used for the disinfection of dental impressions may affect crucial qualities of the impression material, potentially altering surface detail reproduction, surface roughness, and dimensional stability. The results showed that the immersion of impressions made of Type 1 and Type 2 zinc oxide-eugenol impression paste materials in 1:213 Iodophor for 5 minutes, produced no statistically significant dimensional changes in the impressions

and their resultant casts when 2% Gluteraldehyde, 0.2% Chlorhexidine gluconate and 1:213 Iodophor were considered, as compared to the casts of the control group as shown in table no 3 and 4. When two types of zinc oxide-eugenol impression pastes were compared based on mean values for each group of disinfectant by t test, the mean difference between type 1 and type 2 impression material for Chlorhexidine group was found to be statistically non significant ($p=0.1403$), for Iodophor group was found to be statistically non significant ($p=0.0851$), for Distilled water group was found to be statistically non significant ($p=0.3760$). Mean difference between type 1 and type 2 impression material for Gluteraldehyde group was found to be statistically significant ($p=0.0024$) as the difference between mean values between two types was more. Similarly the surface quality was statistically assessed for impressions of type 1 and type 2 zinc oxide-eugenol impression pastes and for four disinfectant solutions using Chi square test, statistically significant difference ($p = 0.0019$) was noted. This difference is noted because, in spite of the oily nature of the surface of impressions made with zinc oxide-eugenol impression paste, the tested disinfectants seemed to have attacked the impression surface chemically and inflicted a noticeable damage. Among four disinfectants, iodophor showed least effect on surface quality. Hence it is verified and concluded that 1:213 Iodophor is the material of choice for disinfection of impressions made with type 1 and type 2 zinc oxide-eugenol impression paste materials. Thus rejecting the null hypothesis as stated earlier.

Summary

The present study was undertaken to determine the disinfectants that could be used, to disinfect zinc oxide-eugenol impressions, from among the disinfectants suggested by ADA and concerned councils, for use in dental situations. Three ADA – accepted disinfectants viz, 0.2 % Chlorhexidine gluconate, 2 % Gluteraldehyde and 1:213 Iodophor were tested where, Distilled water was used as a control.

Recommendations by the concerned councils for dilution of the disinfectants were followed. Resultant casts made from the impressions of Type 1 (Denzomix) and Type 2(DPI) zinc oxide-eugenol impression paste materials after disinfection were evaluated for change in dimensional stability and surface quality. Results of the present study showed that immersion of impressions made of Type 1 and Type 2 zinc oxide-eugenol impression paste materials in 1:213 Iodophor for 5 minutes, produced no statistically significant dimensional changes in the impressions and their resultant casts, as compared to the casts of the control group. The changes seen in surface quality on the resultant casts were not clinically significant. Within the limitations of this study, following conclusions can be made

- 1:213 Iodophor disinfectant solution causes least dimensional and surface quality changes in impressions made from two different zinc oxide-eugenol impression paste materials.
- When compared to 1:213 iodophor disinfectant solution, 2% Gluteraldehyde disinfectant solution causes more dimensional and surface quality changes in impressions made from two different zinc oxide-eugenol impression paste materials.
- 0.2% Chlorhexidine Gluconate disinfectant solution causes the most dimensional and surface quality changes in impressions made from two different zinc

oxide-eugenol impression paste materials when compared to 2% Gluteraldehyde and 1:213 iodophor disinfectant solutions.

Hence, it is advised to consider 1: 213 Iodophor as a selected disinfectant for disinfecting zinc oxide-eugenol impression paste impression materials for 5 minutes.

REFERENCES

- ADA, 1988. Policy statement on AIDS, HIV and Dental practice, ADA News, November 7.
- American Dental Association Guide to Dental Materials, 1977. Revised American Dental Association Specification No.19 for Nonaqueous, Elastomeric Dental impression Materials. *J Am Dent Assoc.*, 94(4):733.
- Council on Dental Materials, 1991. Instruments and Equipment., Disinfection of Impressions, *JADA*, 122: 110.)
- Leung, R.L. and Schonfeld, S.E. 1983. Gypsum Casts as a Potential Source of Microbial cross Contamination. *J Prosthet Dent.*, 49(2): 210-215.
- Neill, MC., M.R., Coulter, W.A. and Hussey, D.L. 1992. Disinfection of irreversible Hydrocolloid Impressions: A Comparative Study. *Int J Prosthodont*, 5(6):563 -567.
- Merchant, V.A., Stone, C.R., Badr, S.E. and Gleason, M.J. 1990. Dimensional Stability of Zinc Oxide- Eugenol Impressions”, *J Dent Res.*, 69:304.
- Olsson, S., Bergman and Bergman, M. 1982. “Zinc Oxide – Eugenol Impression Materials. Dimensional Stability and Surface Detail Sharpness following Treatment with Disinfectant Solutions”, *Swed Dent J.*, 6:177 -180.
- Pagniano, R.P., Scheid, R.C., Clowson, R.L., Dagefoerde, R.O., Zardiackas, L.D. 1982. The Linear Dimensional change of Acrylic Resins used in the Fabrication of Custom Trays. *J Prosthet Dent.*, 47(3):279-283.
- Pleasure, M.A., Duerr, E.L. and Goldman, M. 1959. Eliminating a Hazard in prosthodontic Treatment. *J Prosthet. Dent.*, 9: 814-824.
- Powell, G.L., Rummors, R.D., Saxon, B.A. and Whitsenant, B.K. 1990. The Presence and Identification of organisms’ Transmitted to Dental Laboratories. *J Prosthet Dent* 1990; 64(2):235-237.
- Ralph, W.J., Gin, S.S.I., Cheadle, D.A. and Hercourt, J.K. 1990. The Effects of Disinfectants on the Dimensional Stability of Alginate Impression Materials. *Aust Dent J.*, 35(6):514-517.
- Smith, P. W., R. Richmond and J F Mc Cord, 1999. The design and use of special trays in prosthodontics: guidelines to improve clinical effectiveness. *British Dental Journal*, 187(8), 423 - 426.
- Storer, R. and McCabe, J.F. 1977. “An Investigation of Methods Available for Sterilizing Impressions”, *Br Dent J* 1981, 151:217-219 American Dental Association Guide to Dental Materials: Revised American Dental Association Specification No.19 for Nonaqueous, Elastomeric Dental impression Materials. *J Am Dent Assoc.*, 94(4):733.
- Watkinson, A.C. 1988. Disinfection of Impression in U.K. Dental schools. *Br Dent J.*, 164:22-23.
